

Surface Mount Schottky Rectifier

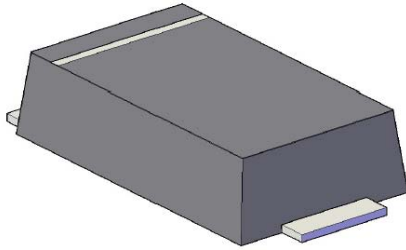

Features

- N+ IMP, Passivation Dep
- Low profile package
- Ideal for automated placement
- Guardring for overvoltage protection
- Low power losses, high efficiency
- High forward surge capability
- Meets MSL level 1, per J-STD-020, LF maximum peak of 260 °C

Typical Applications

For use in low voltage high frequency inverters, freewheeling, DC/DC converters, and polarity protection applications.

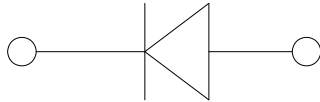

Mechanical Date

- **Package:** SOD-123HE
Molding compound meets UL 94 V-0 flammability rating, RoHS-compliant, halogen-free
- **Terminals:** Tin plated leads, solderable per J-STD-002 and JESD22-B102
- **Polarity:** Cathode line denotes the cathode end

■ Maximum Ratings (T_j=25°C Unless otherwise specified)

PARAMETER	SYMBOL	UNIT	S22EH	S23EH	S24EH	S25EH	S26EH	S28EH	S210EH	S215EH	S220EH
Device marking code			S22EH	S23EH	S24EH	S25EH	S26EH	S28EH	S210EH	S215EH	S220EH
Repetitive peak reverse voltage	VRRM	V	20	30	40	50	60	80	100	150	200
Average rectified output current @60Hz sine wave, Resistance load, TL (FIG.1)	IO	A	2.0								
Surge(non-repetitive)forward current @60Hz half-sine wave,1 cycle, T _j =25°C	IFSM	A	40								
Storage temperature	T _{stg}	°C	-55 ~+150								
Junction temperature	T _j	°C	-55 ~+150				-55 ~+175				

■ Electrical Characteristics (T_j=25°C Unless otherwise specified)

PARAMETER	SYMBOL	UNIT	TEST CONDITIONS	S22EH	S23EH	S24EH	S25EH	S26EH	S28EH	S210EH	S215EH	S220EH
Maximum instantaneous forward voltage drop per diode	V _F	V	IFM=2.0A	0.5			0.7		0.85		0.9	
Maximum DC reverse current at rated DC blocking voltage per diode @ VRM=VRRM	IRR _M	mA	T _j =25°C	0.50					0.10			
			T _j =100°C	10					5			

Note1:Pulse test:300uS pulse width,1% duty cycle

Note2:Pulse test:pulse width 40mS



S22EH THRU S220EH

■ Thermal Characteristics (T_j=25°C Unless otherwise specified)

PARAMETER	SYMBOL	UNIT	S22EH	S23EH	S24EH	S25EH	S26EH	S28EH	S210EH	S215EH	S220EH
Thermal Resistance	R _{θJ-A}	°C/W	80								
	R _{θJ-L}		20								

■ Characteristics (Typical)

FIG1: I_o-T_L Curve

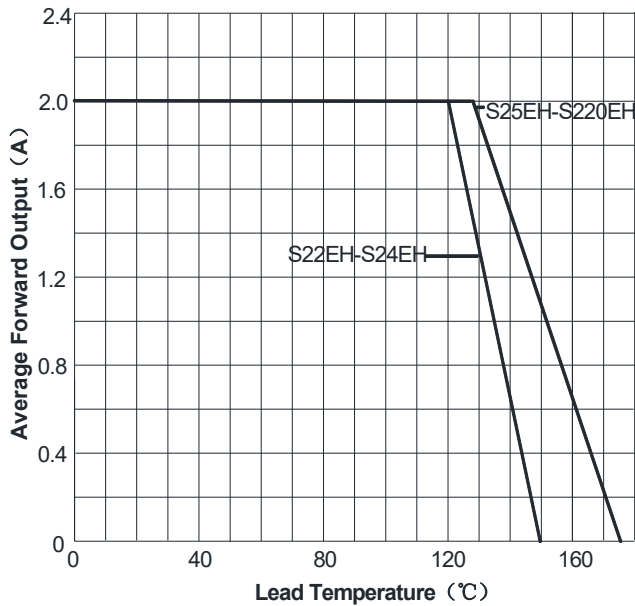

FIG2: Surge Forward Current Capability

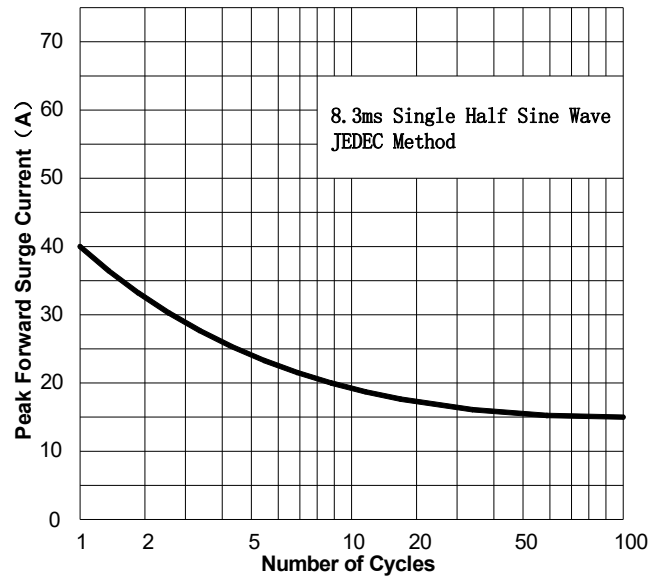

FIG3: Forward Voltage

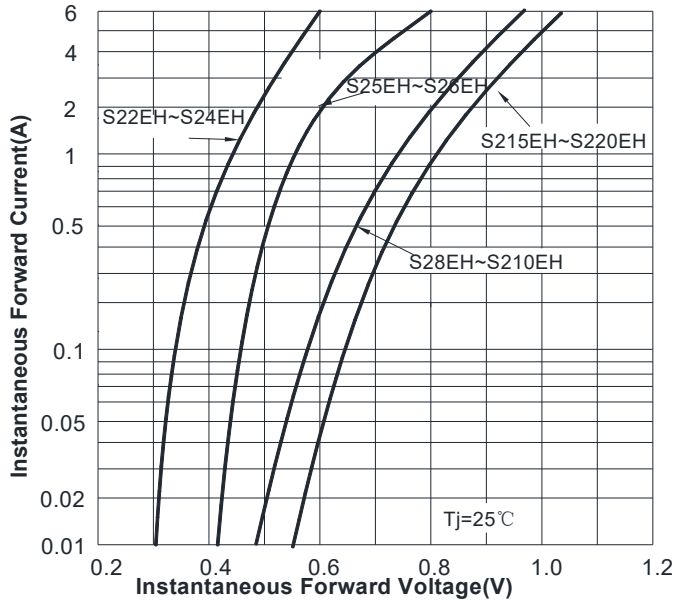
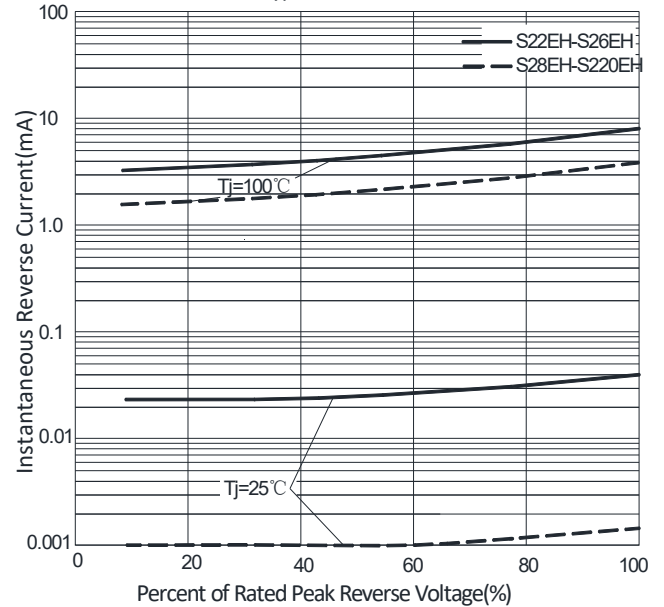

FIG4: Typical Reverse Characteristics





S22EH THRU S220EH

■ Outline Dimensions

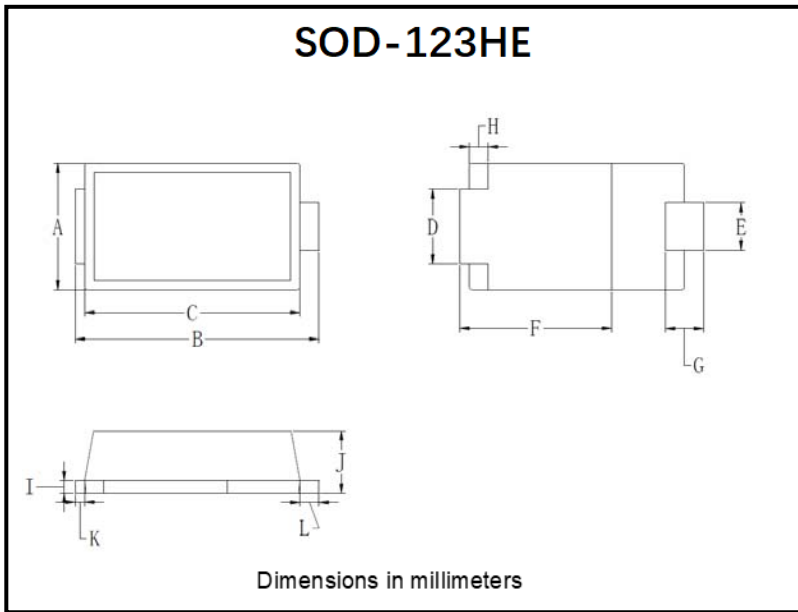

SOD-123HE		
Dim	Min	Max
A	1.88	2.18
B	3.70	4.00
C	3.19	3.61
D	1.05	1.35
E	0.61	0.91
F	2.20	2.90
G	0.40	0.80
H	0.30 TYP	
I	0.10	0.30
J	0.85	1.15
K	0.00	0.30
L	0.15	0.45

■ Suggested pad layout

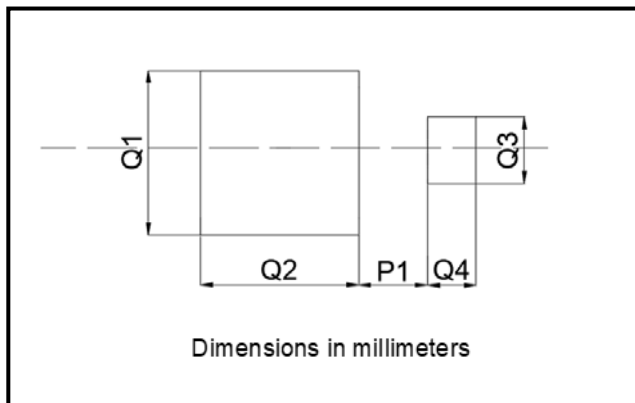

SOD-123HE	
Dim	Millimeters
P1	0.64
Q1	2.54
Q2	2.67
Q3	1.27
Q4	0.76



S22EH THRU S220EH

Disclaimer

The information presented in this document is for reference only. Yangzhou Yangjie Electronic Technology Co., Ltd. reserves the right to make changes without notice for the specification of the products displayed herein to improve reliability, function or design or otherwise.

The product listed herein is designed to be used with ordinary electronic equipment or devices, and not designed to be used with equipment or devices which require high level of reliability and the malfunction of which would directly endanger human life (such as medical instruments, transportation equipment, aerospace machinery, nuclear-reactor controllers, fuel controllers and other safety devices), Yangjie or anyone on its behalf, assumes no responsibility or liability for any damages resulting from such improper use of sale.

This publication supersedes & replaces all information previously supplied. For additional information, please visit our website [http:// www.21yangjie.com](http://www.21yangjie.com) , or consult your nearest Yangjie's sales office for further assistance.